

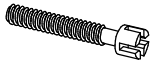







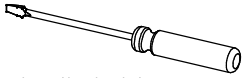

# Montážní návod

A		18 ks	B		18 ks
C	 10x60	20 ks	D		18 ks
E		18 ks			
					
šroubovák křížový			šroubovák plochý		
			gumová palice		

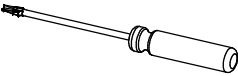
# ALEXIS

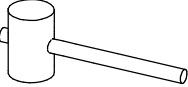

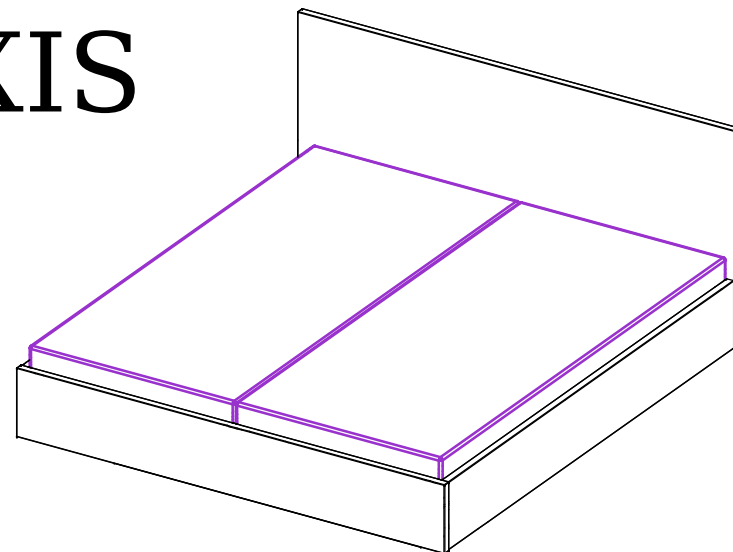
zadní čelo

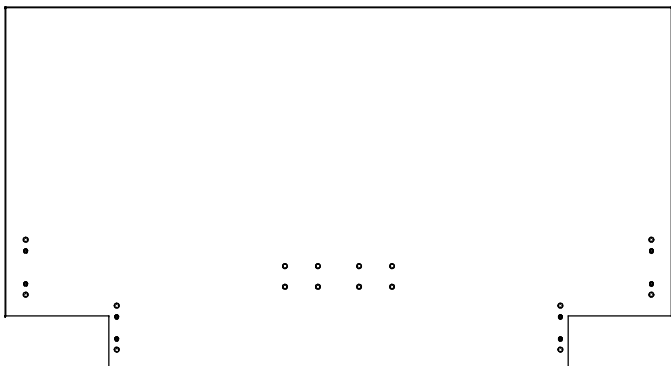

postranice L

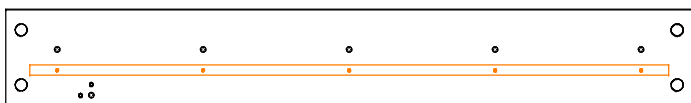

postranice P

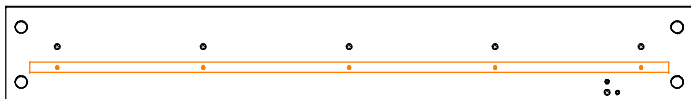

bok úložného prostoru

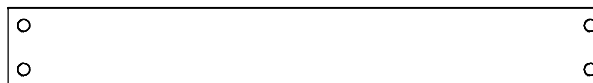

bok úložného prostoru

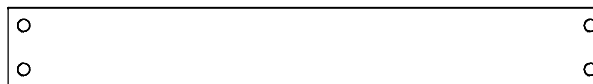

přední čelo

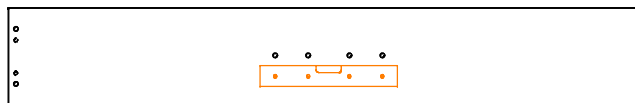

přední díl UP

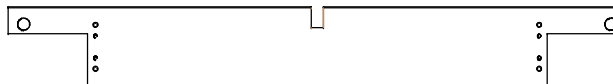

samonosná střednice



1) Do předního a zadního čela našroubujeme šroub (A) s distančním válečkem (E) do závrtné matice cca 5mm do závitu dle nákresu.

2) Narazíme dřevěný kolík (C) do postranic a předního dílu UP.

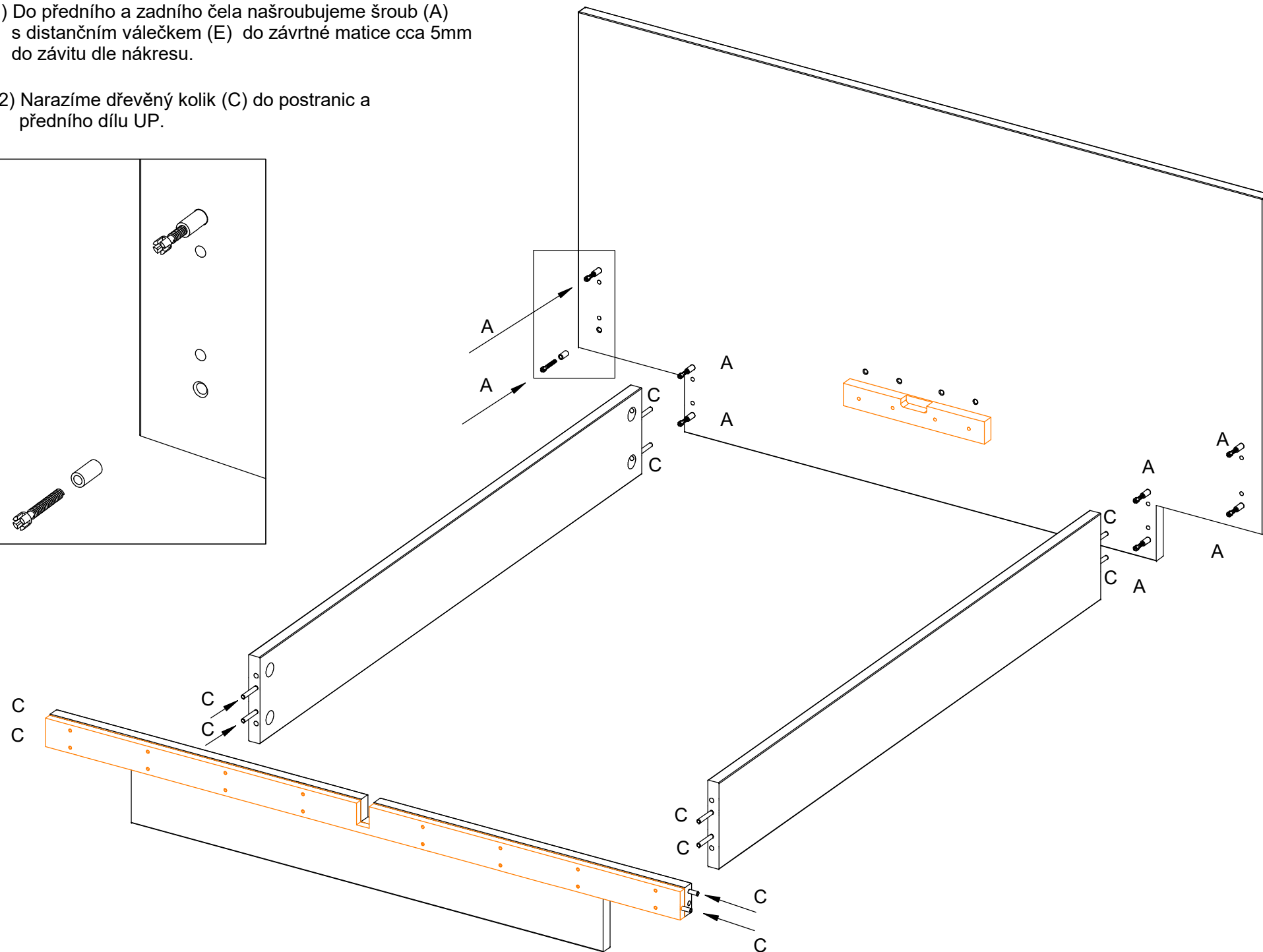
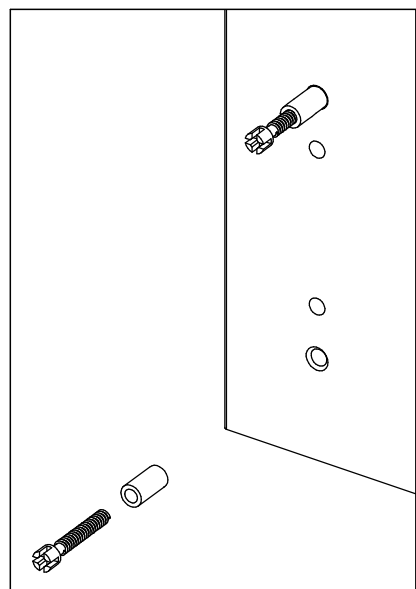

3) Nasadíme segmentový díl (B) a plochým šroubovákem utáhneme dle nákresu. Stejný postup provedeme u postranic a předního čela postele.

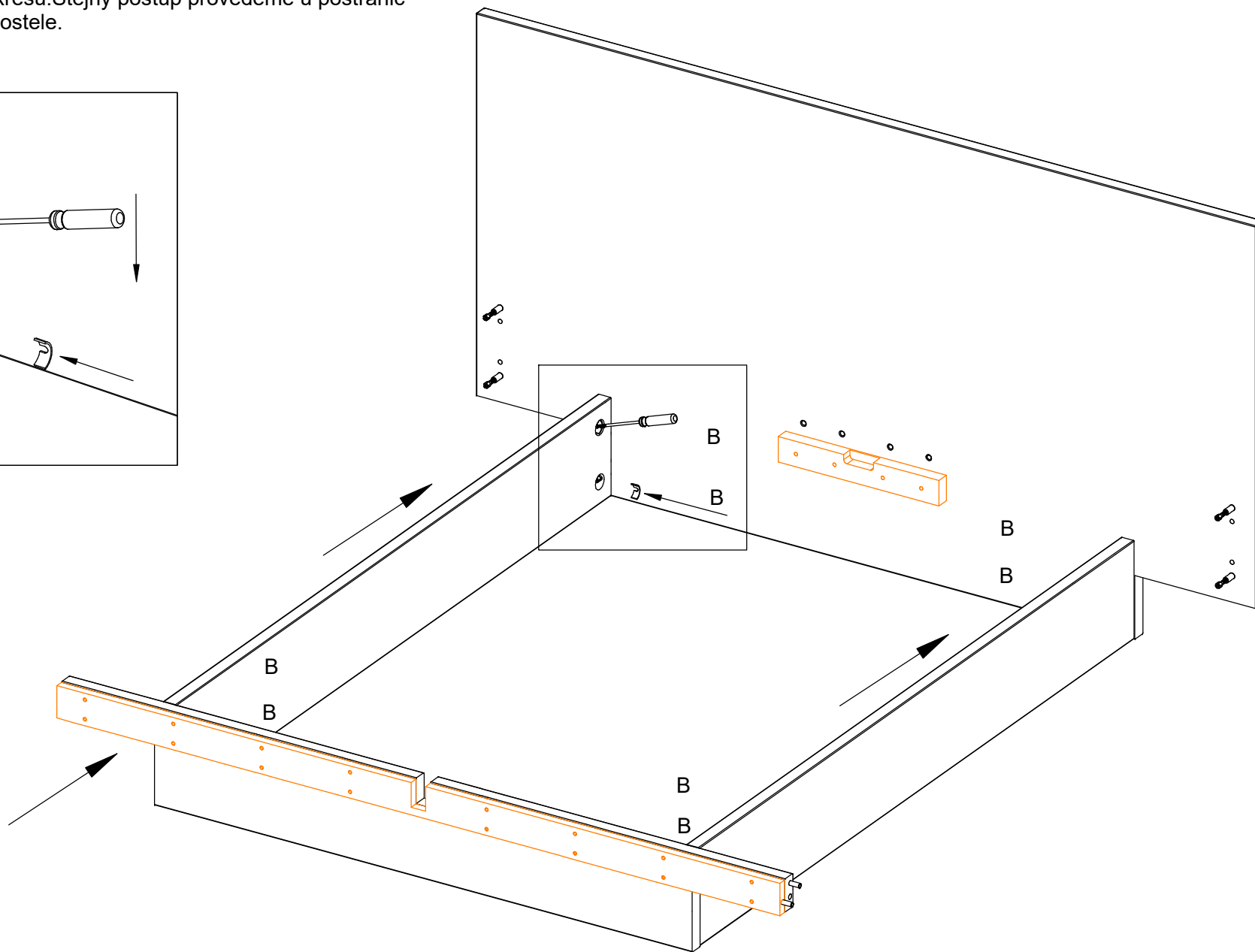
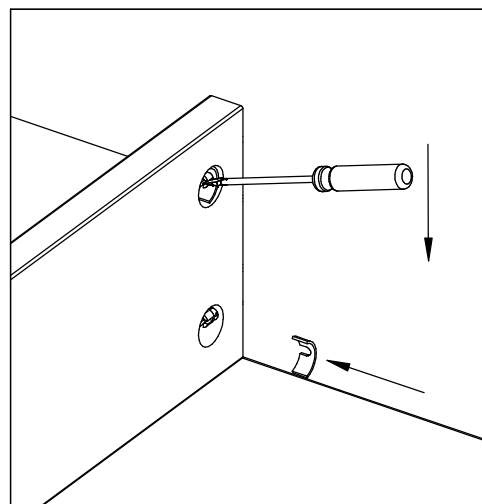

4) Do postranic našroubujeme šroub (A) s válečkem(E)  
a narazíme dřevěný kolík C

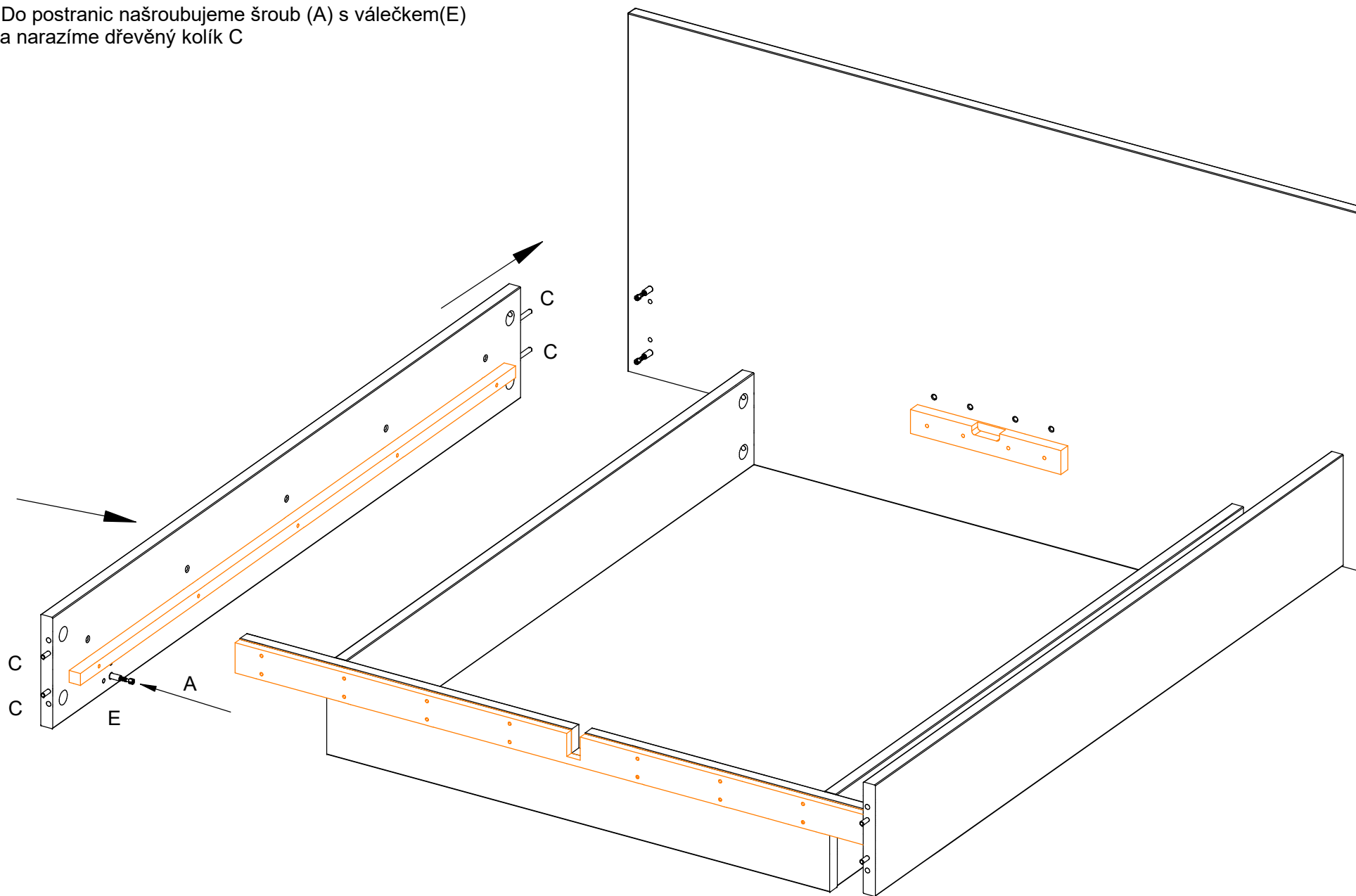

5) Nasuneme přední čelo postele,  
do všech otvorů dáme krytky (D) dle nákresu.

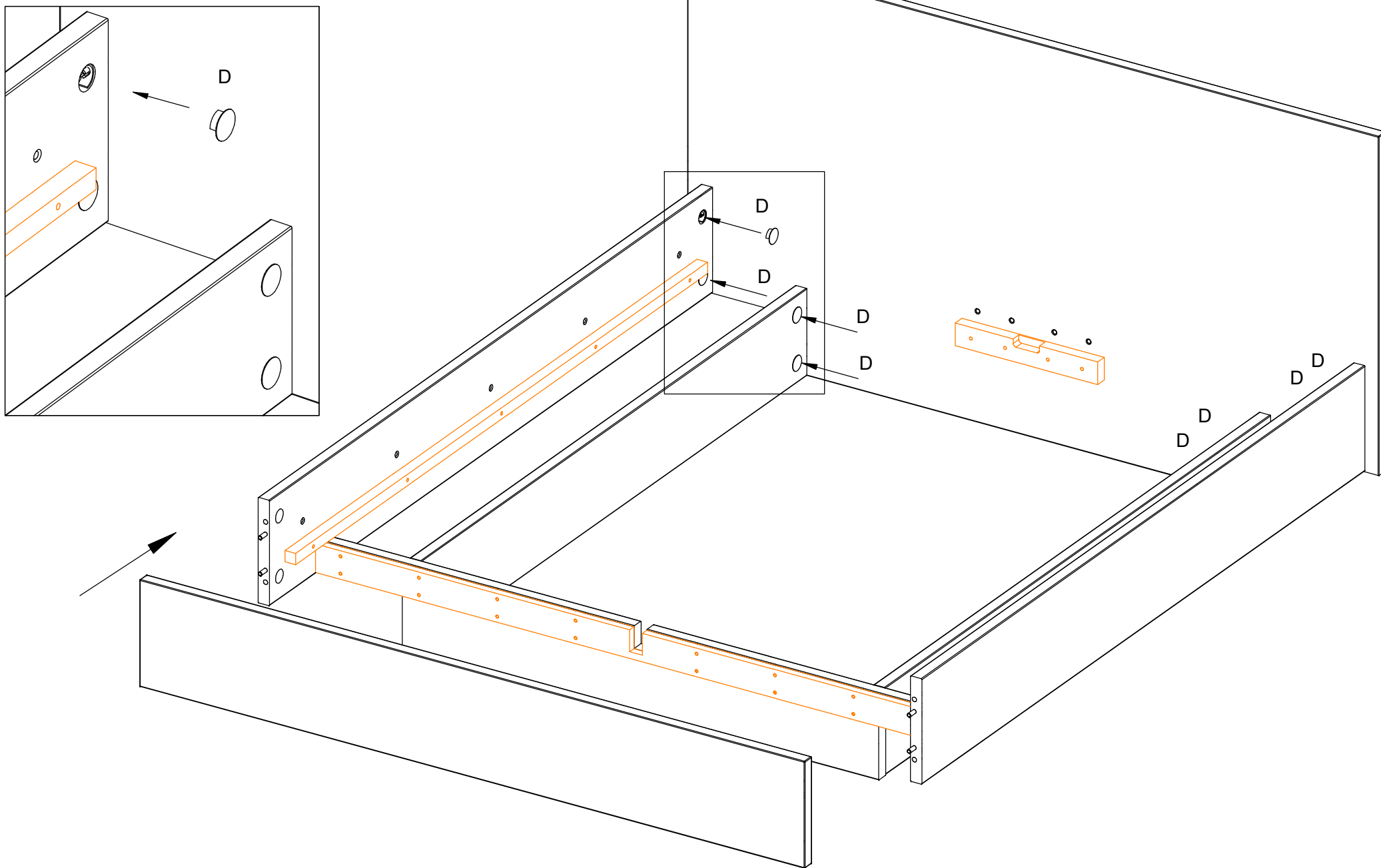

6) Křížovým šroubovákem nastavíme výšku uložení roštů.

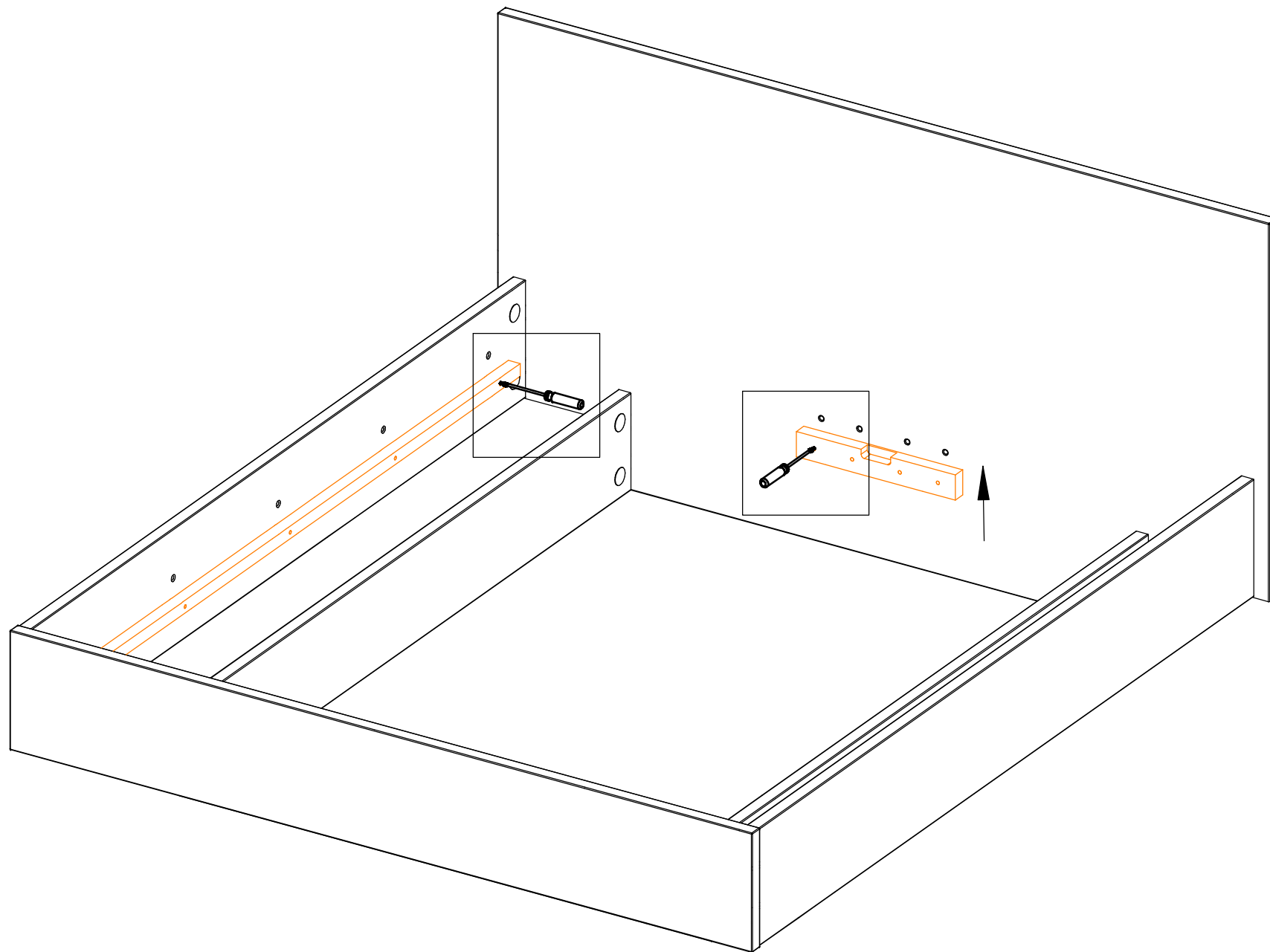

7) Vložíme samonosnou střednici.

